

# Printer Unit Type40 RCP40

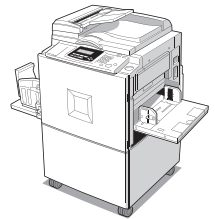

## Operating Instructions Printer Reference 1



- 
- 1 Getting Started
  - 2 Installing the Printer Driver and Software
  - 3 Basic Printing

## Introduction

This manual contains detailed instructions on the operation and maintenance of this machine. To get maximum versatility from this machine all operators should carefully read and follow the instructions in this manual. Please keep this manual in a handy place near the machine.

## Important

Parts of this manual are subject to change without prior notice. In no event will the company be liable for direct, indirect, special, incidental, or consequential damages as a result of handling or operating the machine.

## Warning:

Use of controls or adjustment or performance of procedures other than those specified in this manual might result in hazardous radiation exposure.

## Trademarks

Microsoft®, Windows® and Windows NT® are registered trademarks of Microsoft Corporation in the United States and/or other countries.

Adobe® and Acrobat® are registered trademarks of Adobe Systems Incorporated.

Ethernet® is a registered trademark of Xerox Corporation.

Other product names used herein are for identification purposes only and might be trademarks of their respective companies. We disclaim any and all rights in those marks.

## Notes:

Some illustrations in this manual might be slightly different from the machine.

Certain options might not be available in some countries. For details, please contact your local dealer.

Two kinds of size notation are employed in this manual. With this machine refer to the inch version.

## Note:

The proper names of the Windows operating systems are as follows:

- The product name of Windows® 95 is Microsoft® Windows® 95.
- The product name of Windows® 98 is Microsoft® Windows® 98.
- The product name of Windows® Me is Microsoft® Windows® Millennium Edition (Windows Me).
- The product names of Windows® 2000 are as follows:
  - Microsoft® Windows® 2000 Advanced Server
  - Microsoft® Windows® 2000 Server
  - Microsoft® Windows® 2000 Professional
- The product names of Windows® XP are as follows:
  - Microsoft® Windows® XP Professional
  - Microsoft® Windows® XP Home Edition
- The product names of Windows NT® 4.0 are as follows:
  - Microsoft® Windows NT® Server 4.0
  - Microsoft® Windows NT® Workstation 4.0

# Manuals for This Machine

The following manuals describe the operational procedures and maintenance of this machine.

To enhance safe and efficient operation of this machine, all users should read and follow the instructions carefully.

◆ **Printer Reference 1 (this manual)**

Describes the system settings, procedures and functions for using this machine. This manual is also included as a PDF file on the CD-ROM labeled "Printer Drivers and Utilities".

◆ **Printer Reference 2**

Describes the procedures and provides necessary information about using this machine. This manual is included as a PDF file on the CD-ROM labeled "Printer Drivers and Utilities".

◆ **Network Printing Guide**

Describes the procedures and provides necessary information about setting up and using the printer under the network environment. We recommend this manual as your first choice to read, and it is included as a PDF file on the CD-ROM labeled "Printer Drivers and Utilities".

# How to Read This Manual

---

## Symbols

---

In this manual, the following symbols are used:

### **WARNING:**

This symbol indicates a potentially hazardous situation which, if instructions are not followed, could result in death or serious injury.

### **CAUTION:**

This symbol indicates a potentially hazardous situation which, if instructions are not followed, may result in minor or moderate injury or damage to property.

\* The statements above are notes for your safety.

### **Important**

If this instruction is not followed, paper might be misfed, originals might be damaged, or data might be lost. Be sure to read this.

### **Preparation**

This symbol indicates the prior knowledge or preparations required before operating.

### **Note**

This symbol indicates precautions for operation, or actions to take after misoperation.

### **Limitation**

This symbol indicates numerical limits, functions that cannot be used together, or conditions in which a particular function cannot be used.

### **Reference**

This symbol indicates a reference.

[   ]

Keys that appear on the machine's display panel.

Keys and buttons that appear on the computer's display.

[   ]

Keys built into the machine's control panel.

Keys on the computer's keyboard.

# TABLE OF CONTENTS

**Manuals for This Machine ..... i**  
**How to Read This Manual ..... ii**

## 1. Getting Started

---

**Printer Drivers for This Machine ..... 1**  
**Software and Utilities Included on the CD-ROM ..... 2**  
**Guide to This Machine..... 3**  
    Type A ..... 3  
    Type B ..... 6  
**Network Settings..... 9**  
    Setting on the Control Panel ..... 9  
    Other Settings ..... 14  
**Connecting the Machine ..... 16**  
    Requirements ..... 17  
    Connecting the Network Cable to the Machine ..... 18  
    Connecting the Machine to the Host Using the Parallel Cable ..... 20

## 2. Installing the Printer Driver and Software

---

**Installing the Printer Driver and Software ..... 21**  
**Installing the Raster Printer Language Printer Driver ..... 23**  
    Windows 95/98/Me - Installing the Raster Printer Language Printer Driver ..... 23  
    Windows 2000/Windows XP- Installing the Raster Printer Language Printer Driver ... 24  
    Windows NT 4.0 - Installing the Raster Printer Language Printer Driver ..... 28

## 3. Basic Printing

---

**Printing Data from Your Computer on the Printer ..... 31**  
    Printing ..... 31  
    Changing the Number of Prints During Printing ..... 34  
    Printing (Master Making) with the Different Size of Paper from the Original ..... 35  
**INDEX..... 36**



# 1. Getting Started

## Printer Drivers for This Machine

Printing requires installation of a printer driver for your operating system. The following drivers are included on the CD-ROM labeled "Printer Drivers and Utilities" that comes with the machine.

Operating system	Printer Language	Raster Printer Language
Windows 95 <sup>*1</sup>		√
Windows 98 <sup>*2</sup>		√
Windows Me <sup>*3</sup>		√
Windows 2000 <sup>*4</sup>		√
Windows XP <sup>*5</sup>		√
Windows NT 4.0 <sup>*6</sup>		√

<sup>\*1</sup> Microsoft Windows 95 operating system

<sup>\*2</sup> Microsoft Windows 98 operating system

<sup>\*3</sup> Microsoft Windows Millennium Edition

<sup>\*4</sup> Microsoft Windows 2000 Professional  
Microsoft Windows 2000 Server

<sup>\*5</sup> Microsoft Windows XP Professional  
Microsoft Windows XP Home Edition

<sup>\*6</sup> Microsoft Windows NT Server operating system version 4.0, Microsoft Windows NT Workstation operating system version 4.0 in a computer using x86 processors.

### ◆ Raster Printer Language printer drivers

The Raster Printer Language printer driver is the mini-driver that belongs to the operating system. Installing the file that is included on the CD-ROM sets the mini-driver as the printer driver of this machine. Printer drivers allow the computer to communicate with the printer via a printer language.

See p.23 "Windows 95/98/Me - Installing the Raster Printer Language Printer Driver"

See p.24 "Windows 2000/Windows XP- Installing the Raster Printer Language Printer Driver"

See p.28 "Windows NT 4.0 - Installing the Raster Printer Language Printer Driver"

The Printer driver varies depending on the machine model.

Machine model	Machine resolution	Printer driver
Type A 600 dpi	600 dpi	Type40 600
Type A 400 dpi	400 dpi	Type40 400 A
Type B	400 dpi	Type40 400 B

# Software and Utilities Included on the CD-ROM

1

There is a CD-ROM that comes with the machine. The CD-ROM is labeled “Printer Drivers and Utilities”. The following items are included on the CD-ROM:

## ❖ **SmartDeviceMonitor for Admin**

This utility is for the system administrator to manage printers on the network.

### **Reference**

See SmartDeviceMonitor for Admin online Help for more information about using the SmartDeviceMonitor for Admin.

## ❖ **SmartDeviceMonitor for Client**

This utility is for users to manage their own print status on the network.

### **Reference**

See SmartDeviceMonitor for Client online Help for more information about using the SmartDeviceMonitor for Client.

## ❖ **Acrobat Reader**

This utility allows you to read PDF (Portable Document Format).

### **Note**

- Documentation about using the machine is included on the CD-ROM in PDF. See Acrobat Reader online Help for more information about using Acrobat Reader.

## **Important**

- If you upgrade to Windows 2000 from Windows 95/98/Me or Windows NT 4.0, the software and utilities must be uninstalled prior to installing Windows 2000. Reinstall them in the Windows 2000 environment.



# Guide to This Machine

## Note

- The location of keys and indicators vary depending on machine models, Type A and Type B.

## Type A

### Control panel

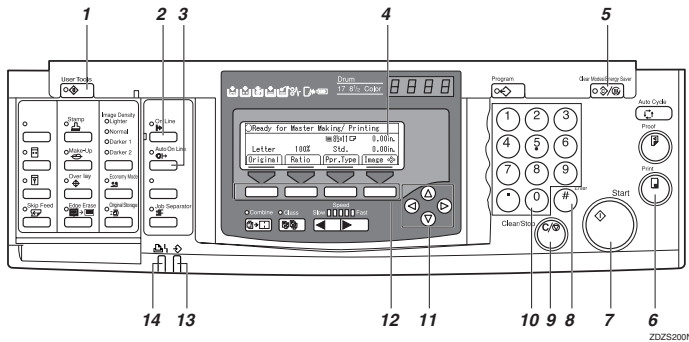

### 1. [User Tools] key

Press to change the default to meet your requirements.

### 2. [On Line] key

Allows data on a computer to be printed on this machine (online status).

## Note

- When the Auto On Line indicator is lit, the machine will automatically enter the online status when receiving data from a computer without having to press the [On Line] key.

### 3. [Auto On Line] key

You can select whether the machine automatically switches to On Line mode when it receives data from a computer.

When pressing this key to turn on Auto On Line, the indicator will light. Then, when data from a computer is received, the machine will automatically enter the On Line status (In this case, it is not necessary to press the [On Line] key).

### 4. Display Panel

Shows operation status, error messages, and function menus.

### 5. [Clear Modes/Energy Saver] key

Press to cancel the current settings. The machine settings return to their default. When the machine is in Energy Saver status, press [Clear Modes/Energy Saver] key to cancel Energy Saver status and to return to the normal status.

**6. [Print] key**

Press to start printing.

**7. [Start] key**

Press to start master making.

**8. [#] key**

Press to confirm an entered value.

**9. [Clear/Stop] key**

Press to delete a number entered or to stop printing.

**10. Number keys**

Press to enter the desired number of prints and data for selected modes.

**11. [◀][▶][△][▽] keys**

Use to highlight items you wish to select on the display panel.

**12. Function keys**

These keys correspond to the selectable items on the display panel.

**13. Data In indicator (Green)**

Indicates the status of this machine:

- On: Data waiting for Master Making and printing is in the machine.
- Blinking: Data is being received, or Master Making or printing is in progress.
- Off: Master Making and printing are completed.

**14. Error indicator (Red)**

Indicates the status of this machine:

- On: An error has occurred. Master Making and printing stop.
- Off: Normal status

**Display panel**

The display panel shows the status of the machine, error messages and function menus.

**Important**

- Do not apply a strong shock or force of about 30 N (about 3 kgf) or more to the display panel. Otherwise, the display can get damaged.

**Displays and key operations**

The display panel shows the machine status, error messages, and function menus.

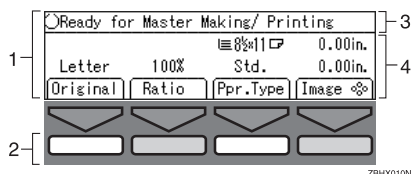

**1. Items for the selected function.**

**2. These keys correspond to the selectable items shown above them on the display panel. To select an item shown on the display panel, press the key directly below it.**

**3. Machine status or messages.**

**4. Items which can be selected.**

◆ **Common key explanations**

[OK]	Confirms a function selection or an entered value.
[Cancel]	Cancels a function selection or an entered value and returns to the previous display.
[Prev.][Next]	When there are too many items to fit on the display panel, use these keys to move between pages.
[◀][▶][▲][▼][←][→]	Press to highlight items you wish to select on the display panel.
[Select]	Selects a value.
[Exit]	Returns to the previous display.

 **Note**

- When you select an item on the display panel, it is highlighted (e.g. **Auto**).
- Items shown dimmed (e.g. **OK**) cannot be selected.

**Offline/Online**

The screens displayed are different in the online status and offline status.

 **Note**

- When the machine is offline, it cannot receive data from a computer.
- When the machine is online, it can receive data from a computer.

**Offline**

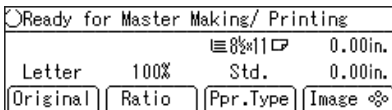

**Online**

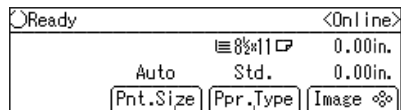

EG0002

**1. [Pnt.Size]**

The paper size in the Paper Feed Tray can be selected.

 **Note**

- When “Auto” is selected, the paper size in the Paper Feed Tray will be automatically detected.
- A message “Paper size mismatch...” appears on the display panel when the paper size in the Paper Feed Tray is different from the paper size of data set on the computer. Set paper of the correct size.

 **Reference**

For information about the other setting items on the display panel, see *Operating Instructions*.

**2. [Ppr.Type]**

You can specify the type of paper on Paper Feed Tray.

## Setting the size of paper

The machine automatically detects the size of paper on Paper Feed Tray, and then the size of paper appears on the display panel.

## Type B

### Control panel

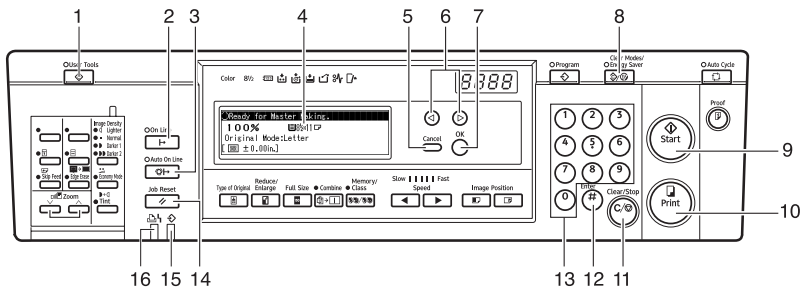

ZLKS010N

#### 1. **[User Tools]** key

Press to change the default to meet your requirements.

#### 2. **[On Line]** key

Allows data on a computer to be printed on this machine (online status).

#### **Note**

- when the Auto On Line indicator is lit, the machine will automatically enter the online status when receiving data from a computer without having to press the **[On Line]** key.

#### 3. **[Auto On Line]** key

You can select whether the machine automatically switches to On Line mode when it receives data from a computer.

When pressing this key to turn on Auto On Line, the indicator will light. Then, when data from a computer is received, the machine will automatically enter the On Line status (In this case, it is not necessary to press the **[On Line]** key).

#### 4. **Display Panel**

Shows operation status, error messages, and function menus.

#### 5. **[Cancel]** key

Cancels a function selection or an entered value and returns to the previous display.

#### 6. **[<][>]** keys

Use to highlight items you wish to select on the display panel.

#### 7. **[OK]** key

Press to confirm a function selection or an entered value.

#### 8. **[Clear Modes/Energy Saver]** key

Press to cancel the current settings. The machine settings return to their default settings.

When the machine is in Energy Saver status, press **[Clear Modes/Energy Saver]** key to cancel Energy Saver status and to return to the normal status.

**9. 【Print Start】 key**

Press to start printing.

**10. 【Make Master】 key**

Press to start master making.

**11. 【Clear/Stop】 key**

Press to delete a number entered or to stop printing.

**12. 【#】 key**

Press to confirm an entered value.

**13. Number key**

Press to enter the desired number of prints and data for selected modes.

**14. 【Job Reset】 key**

Press to cancel master making.

**15. Data In indicator (Green)**

Indicates the status of this machine:

On: Data waiting for Master Making and printing is in the machine.

Blinking: Data is being received, or Master Making or printing is in progress.

Off: Master Making and printing are completed.

**16. Error indicator (Red)**

Indicates the status of this machine:

On: An error has occurred. Master Making and printing stops.

Off: Normal status.

**Display panel**

The display panel shows the status of the machine, error messages and function menus.

**Important**

- Do not apply a strong shock or force of about 30 N (about 3 kgf) or more to the display panel. Otherwise, the display can get damaged.

**Displays and key operations**

The display panel shows the machine status, error messages, and function menus.

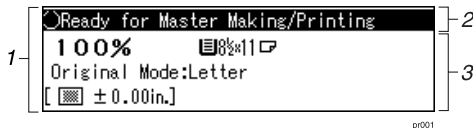

- 1. Items for the selected function.
- 2. Machine status or messages.
- 3. Items which can be selected.

**Common key explanations**

【OK】 key	Confirms a functions selection or an entered value.
【Cancel】 key	Cancels a function selection or an entered value and returns to the previous display.
【<】【>】 key	Press to highlight items you wish to select on the display panel.

---

## Offline/Online

---

The screens displayed are different in the online status and offline status.

1

### Note

- When the machine is offline, it cannot receive data from a computer.
- When the machine is online, it can receive data from a computer.

### Offline

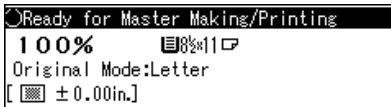

### Online



p1002pr011

## 1. Paper Size

The size of paper on Paper Feed Tray is displayed.

## 2. Print Size

The paper size in the Paper Feed Tray can be selected.

### Note

- When “Auto” is selected, the paper size in the Paper Feed Tray will be automatically detected.
- A message “Paper size mismatch...” appears on the display panel when the paper size in the Paper Feed Tray is different from the paper size of data set on the computer. Set paper of the correct size.

---

## Setting the size of paper

---

The machine automatically detects the size of paper on Paper Feed Tray, and then the size of paper appears on the display panel.

# Network Settings

You can make the necessary network settings using the control panel of this machine.

It is also possible to use “SmartDeviceMonitor for Admin” when making settings for IP addresses in environments you can use TCP/IP.

## Setting on the Control Panel

Make the settings for necessary items for the network environment you are going to use.

The followings are the items that can be set as well as the factory settings:

Item	Factory settings
IP Address	011.022.033.044
Network boot	None

### Type A

- 1 Press the **[User Tools]** key.

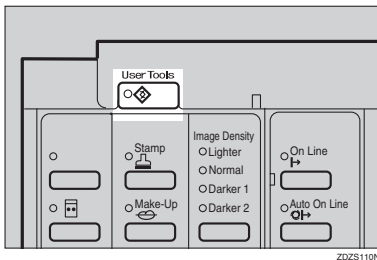

The User Tools screen appears.

- 2 Press **[Next]**.
- 3 Select **[7 Set O/L Paramet's]** using the **[<]**, **[>]**, **[Δ]** or **[▽]** keys.
- 4 Press **[OK]**.

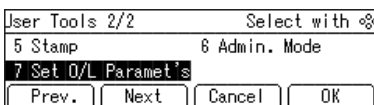

The Online Parameter Settings items appear.

**5** Press [Next].

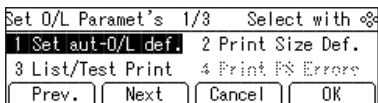

**6** Set the IP address.

**1** Select [5 IP Address] using the [◀], [▶], [▲] or [▼] key.

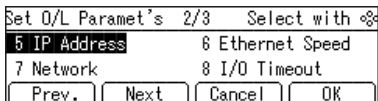

**2** Press [OK].

The IP address setting screen appears.

**3** Enter the IP address using the number keys.

- You can change the numbers that are highlighted.
- The cursor can be moved using the [◀] key or the [▶] key.
- The numbers are entered 3 digits at a time.

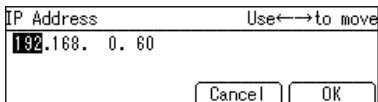

**4** Press [OK].

After finishing the IP address settings, the screen returns to the screen on step 5.

**7** If necessary, make the Network boot settings.

**1** Select [7 Network] using the [◀], [▶], [▲] or [▼] keys.

**2** Press [OK].

The network boot settings screen appears.

**3** Select the Network boot to be set using the [◀], [▶], [▲] or [▼] keys.

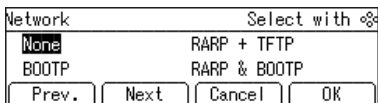

Item	Valid method *1			
	AP	RA	BO	DH
ARP+PING	○			
ARP&RARP	○	○		
ARP&BOOTP	○		○	



Item	Valid method *1			
	AP	RA	BO	DH
ARP&RARP&BOOTP	<input type="radio"/>	<input type="radio"/>	<input type="radio"/>	
None (Factory Settings)				
RARP+TFTP		<input type="radio"/>		
BOOTP			<input type="radio"/>	
RARP&BOOTP		<input type="radio"/>	<input type="radio"/>	
DHCP				<input type="radio"/>

\*1 The valid methods are in order from the left: ARP+PING, RARP+TFTP, BOOTP, DHCP.

### Note

- It is necessary to set the server when using RARP+TFTP, BOOTP, and DHCP.
- When setting the IP address on the control panel, use None.

### Reference

See *Network Printing Guide* when using DHCP.

#### 4 Press the [OK].

This completes the Network boot settings.

#### 8 Press the [User Tools] key.

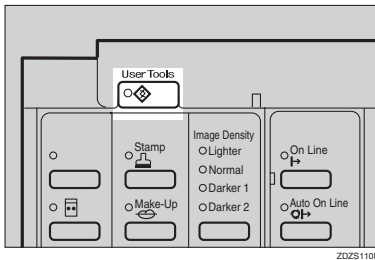

A message "Parameter settings have been changed. You must restart the machine before the new settings take effect." appears on the display panel.

#### 9 Turn off and on the main power switch of the machine.

The set items become valid.

## Type B

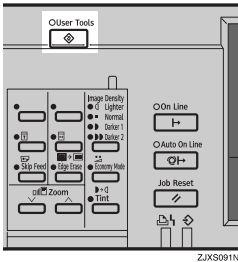
**1** Press the **[User Tools]** key

The User Tools screen appears.

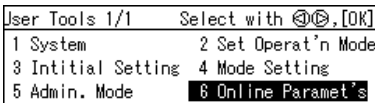
**2** Select **[6 Online Paramet's]** using the **[<]** key or the **[>]** key.**3** Press the **[OK]** key.

The Online Parameter Settings items appear.

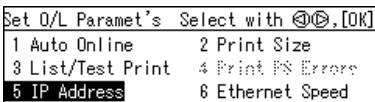
**4** Set the IP address.**1** Select **[5 IP Address]** using the **[<]** key or the **[>]** key.**2** Press the **[OK]** key.

The IP address setting screen appears.

**3** Enter the IP address using the number keys.

- You can change the numbers that are highlighted.
- The cursor can be moved using the **[<]** key or **[>]** key.
- The numbers are entered 3 digits at a time.

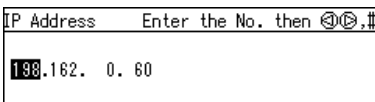
**4** Press the **[OK]** key.

After finishing the IP address settings, the screen returns to the screen on step **3**.

## 5 If necessary, make the Network boot settings.

① Select [7 Network] using the [◀] key or [▶] key.

② Press the [OK] key.

The network boot settings screen appears.

③ Select the Network boot to be set using the [◀] key or [▶] key.

Network	1/2	Select with	⊙, [OK]
None		RARP + TFTP	
BOOTP		RARP & BOOTP	
DHCP		ARP + PING	

Item	Valid method *1			
	AP	RA	BO	DH
ARP+PING	<input type="radio"/>			
ARP&RARP	<input type="radio"/>	<input type="radio"/>		
ARP&BOOTP	<input type="radio"/>		<input type="radio"/>	
ARP&RARP&BOOTP	<input type="radio"/>	<input type="radio"/>	<input type="radio"/>	
None (Factory Settings)				
RARP+TFTP		<input type="radio"/>		
BOOTP			<input type="radio"/>	
RARP&BOOTP		<input type="radio"/>	<input type="radio"/>	
DHCP				<input type="radio"/>

\*1 The valid methods are in order from the left: ARP+PING, RARP+TFTP, BOOTP, DHCP.

### Note

- It is necessary to set the server when using RARP+TFTP, BOOTP, and DHCP.
- When setting the IP address on the control panel, use None.

### Reference

See *Network Printing Guide* when using DHCP.

④ Press the [OK] key.

This completes the Network boot settings.

**6** Press the **[User Tools]** key.

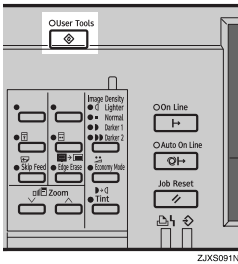

A message “Parameter settings have been changed. You must restart the machine before the new settings take effect.” appears on the display panel.

**7** Turn off and on the main power switch of the machine.

The set items become valid.

## Other Settings

The followings are other items you can set using the control panel besides the IP address and the Network boot:

**Note**

- The settings are performed in Web Status Monitor or SmartDeviceMonitor for Admin. See the corresponding online Help for details.

Items	Factory Settings
Subnet mask	000.000.000.000
Default gateway address	000.000.000.000
Access control address	000.000.000.000
Access control mask	000.000.000.000
Frame Type (Netware)	Automatic selection
Valid protocol	All valid

## About addresses

### ◆ Subnet mask

Mask value for using one part of an IP Address as a network address.

### ◆ Default gateway address

Host or router address used as a gateway when negotiating with (printing, information gathering) a workstation on a different network.

### Note

- Check with your network administrator for the address to be set.
- If you do not know the address to be set, use the factory settings.

## About access control

The access control address and the access control mask are used to limit a printable workstation, by using an IP address. If it is not necessary to limit printing, set "0.0.0.0".

### Note

- If the access control address mask and the mask of the address of the workstation trying to print is the same, then access will be granted.
- For example, if the access control address is set to 192.168.15.16, depending on the mask value, the address of the accessible workstation is as follows: (XXX can be any value).

Access control mask	Accessible Addresses
0 . 0 . 0 . 0	<b>XXX . XXX . XXX . XXX</b>
255 . 0 . 0 . 0	<b>192 . XXX . XXX . XXX</b>
255 . 255 . 0 . 0	<b>192 . 168 . XXX . XXX</b>
255 . 255 . 255 . 0	<b>192 . 168 . 15 . XXX</b>
255 . 255 . 255 . 255	<b>192 . 168 . 15 . 16</b>

# Connecting the Machine

1

## ❖ Type A

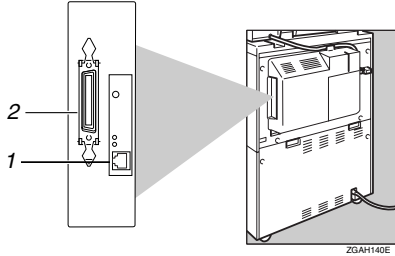

## ❖ Type B

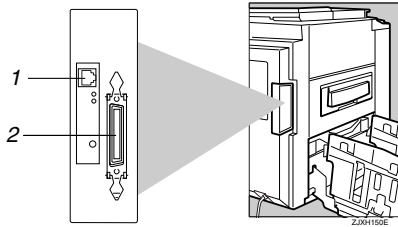

### 1. Ethernet Interface

Connector for the 100BASE-TX or 10BASE-T cable used when connecting to the network.

### 2. Parallel Interface

Connector for the parallel interface cable used when connecting to a computer.

---

## Requirements

---

---

### Requirements

---

Before using this machine, make sure that all the environmental and electrical requirements have been met. Connect the machine to the host computer using the parallel port, Network Interface Board, or both.

Make sure that all the cables, connectors, and electrical outlets necessary to attach the machine to the host computer or network are present.

#### Important

- The interface cable is not supplied. It is your responsibility to provide the interface cable appropriate for the computer that you are using.

#### Reference

For Ethernet Board connection, see p.18 “Connecting the Network Cable to the Machine”.

For more information about using the parallel port, see p.20 “Connecting the Machine to the Host Using the Parallel Cable”.

---

### Interface cable requirements

---

As the cables may differ depending on the type of computer, make sure you check your computer and prepare the appropriate cable.

#### Note

- Use a shielded cable for the interface cable. Using another cable, instead of shielded cables, may cause radio interference.

---

### Parallel cable requirements

---

Connect the machine to the host computer using a parallel port. This machine does not provide the parallel cable to connect the machine to the host computer.

The machine's parallel interface is a standard bidirectional interface. It requires a standard 36-pin parallel cable compliant with IEEE 1284 and a parallel port available on the host computer.

#### Note

- Do not use a parallel cable that is longer than 3 meters (10 feet).

---

## Connecting the Network Cable to the Machine

---

1

### Important

- Before connecting an interface cable between the machine and a computer, make sure that the machine is not operating, and then turn off the main power switches of the machine and the computer.
- Be sure to use the designated interface cable. Using another cable may cause radio interference.

After setting up this machine to support the network environment, connect the Ethernet interface cable. Connect a 10BASE-T or 100BASE-TX cable to the Ethernet board.

- 1** Connect the Ethernet interface cable into the Ethernet interface at the right side of the back of the machine.

#### ◆ Type A

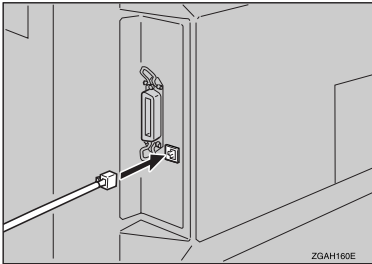

#### ◆ Type B

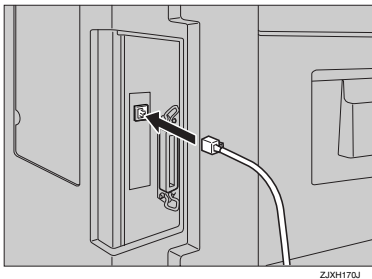



## 2 Turn on the main power switch.

### ◆ Using the switches and understanding the LEDs

#### ◆ Type A

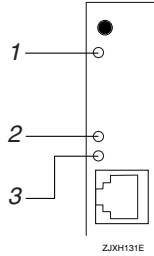

#### ◆ Type B

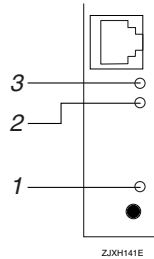

**1.** Is on while the Ethernet board is working properly.

**2.** Is on while the 100BASE-TX is working, and off when the 10BASE-T is working.

**3.** Is on while the machine is properly connected to the network.

## Connecting the Machine to the Host Using the Parallel Cable

1

Connect the machine to the host computer using a parallel cable compliant with IEEE 1284 (available separately).

Follow these steps to connect the machine to the host computer.

### **Important**

- Before connecting an interface cable between the machine and a computer, make sure that the machine is not operating, and then turn off the main power switches of the machine and the computer.
- Be sure to use the designated interface cable. Using another cable may cause radio interference.

**1** Plug the 36-pin end of the parallel cable into the parallel port at the right side on the back of the machine.

**2** Squeeze the wire clips on each side of the connector until they snap into place. The clips hold the cable securely in place.

#### ◆ Type A

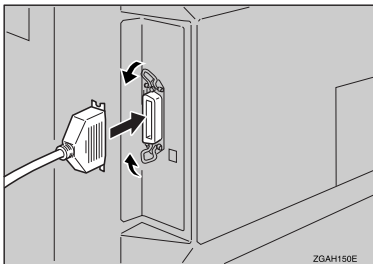

ZGAH150E

#### ◆ Type B

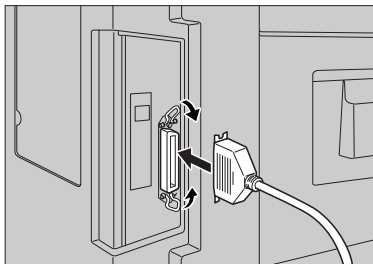

ZJXH160J

**3** Plug the other end of the parallel cable into the computer's parallel port. If there are the wire clips, squeeze them on each side of the connector together.

# 2. Installing the Printer Driver and Software

## Installing the Printer Driver and Software

This manual assumes that you are familiar with general Windows procedures and practices. If you are not, see the documentation that comes with Windows for details.

### **Note**

- In this manual, “CD-ROM” refers to the “Printer Drivers and Utilities” CD-ROM that comes with the machine unless specified otherwise.

### **Reference**

For more information about the printer drivers, see p.1 “Printer Drivers for This Machine”.

For more information about the software and utilities, see p.2 “Software and Utilities Included on the CD-ROM”.

### **Important**

- Before starting the installation, close all documents and applications. In a network environment, make sure that users who are logged on are disconnected.
- After installing a printer driver, you must restart the computer.

### **Note**

- Use the appropriate language on the CD-ROM folder: ENGLISH (English), DEUTSCH (German), FRANCAIS (French), ITALIANO (Italian), ESPANOL (Spanish), NEDRLNDS (Dutch).
- The languages displayed in the WSMHLP folder (Web Status Monitor Help) in the Help folder on the CD-ROM are as follows: DE (German), EN (English), ES (Spanish), FR (French), IT (Italian), NL (Dutch).

 **Using the shared printer on Windows 2000/Windows XP or Windows NT 4.0 for Windows 95/98/Me Client or Windows NT 4.0 Client**

❖ **Windows 2000/Windows XP**

If you want to share the machine on Windows 2000/Windows XP, install the printer driver of Windows 95/98/Me or Windows NT 4.0 as an alternate driver.

❖ **Windows NT 4.0**

If you want to share the machine on Windows NT 4.0, install the printer driver of Windows 95/98/Me as an alternate driver.

 **Note**

- When using the “alternate driver” function with the Windows NT 4.0, use the Windows NT 4.0 Service Pack 6 or later.

For more information about installing the printer driver as an alternate driver, see p.24 “Windows 2000/Windows XP- Installing the Raster Printer Language Printer Driver”, p.28 “Windows NT 4.0 - Installing the Raster Printer Language Printer Driver”.

# Installing the Raster Printer Language Printer Driver

This section describes basic instructions for installing the Raster Printer Language printer driver. The actual procedure may vary depending on the operating system. Follow the appropriate procedure below.

## Important

- When updating the printer driver by installing the latest version, you should uninstall the former version . See “Uninstalling the Printer Driver and Software” in *Printer Reference 2*.

---

## Windows 95/98/Me - Installing the Raster Printer Language Printer Driver

---

### Preparation

The Windows 95/98 CD-ROM may be required during installation. Make sure to have the CD-ROM ready before installation.

- 1** Close all applications that are currently running.
- 2** Click [Start] on the taskbar, point to [Settings], and then click [Printers].  
The [Printers] window appears.
- 3** Double-click the [Add Printer] icon.  
[Add Printer Wizard] starts.
- 4** Click [Next].
- 5** Check [Local printer] and click [Next].  
A dialog box for selecting the manufacturer and model name appears.
- 6** Click [Have Disk].  
A dialog box for installing the printer driver from a disk appears.
- 7** Insert the CD-ROM into the CD-ROM drive.
- 8** Click [Browse].
- 9** Use the [Drives] list box to select the CD-ROM drive.
- 10** In the [Folders] box, double-click [Drivers], and then [WIN9x\_ME]. Then double-click the folder of the appropriate language for the operating system.
- 11** Click [OK].

**12** Click **[OK]**.

A dialog box for selecting the machine model appears.

**13** Click to select the name of the machine whose driver you want to install, and then click **[Next]**.**Important**

- Select the printer driver for your machine as shown.

Machine model	Machine resolution	Printer driver
Type A 600 dpi	600 dpi	Type40 600
Type A 400 dpi	400 dpi	Type40 400 A
Type B	400 dpi	Type40 400 B

**14** In the **[Available ports]** box, click to select **[Printer Port]**, and then click **[Next]**.

A dialog box for changing the printer name appears.

**15** Change the name of the machine if you want, and then click **[Finish]**.**16** The installation is complete.

---

## Windows 2000/Windows XP- Installing the Raster Printer Language Printer Driver

---

**Limitation**

- Installing a printer driver requires Manage Printers permission. Members of the Administrators and Power Users groups have Manage Printers permission by default. When you install a printer driver, log on using an account that has Manage Printers permission.

**Note**

- If you want to share the machine on Windows 2000/Windows XP, use the **[Sharing]** tab in the **[Printer Properties]** dialog box to specify the alternate printer driver. For details, see the operating instructions for Windows 2000/Windows XP.
- When prompted for the alternate printer driver location, select the following folder on the CD-ROM:
  - Windows 95/98/ME:\ Drivers \ WIN9x\_ME \ (Language)
  - Windows 2000, Windows XP:\ Drivers \ WIN2000\_XP \ (Language)
  - Windows NT4.0:\ Drivers \ WINNT40 \ (Language)
- When Raster Printer Language driver of Windows 95/98/Me is shared on Windows 2000, follow ARTICLE -ID:Q142667 of Microsoft Knowledge Base to install a printer driver.

**1** Close all applications that are currently running.

**2** Click **[Start]** on the taskbar, point to **[Settings]**, and then click **[Printers]**.

The **[Printers]** window appears.

 **Note**

- With Windows XP Professional, access the **[Printers and Faxes]** window from **[Start]** on the taskbar.
- With Windows XP Home Edition, access the **[Printers and Faxes]** window by clicking **[Start]** on the taskbar. Then click **[Control Panel]**, **[Printers and Other Hardware]** and then **[Printers and Faxes]**.

**3** Double-click the **[Add Printer]** icon.

**[Add Printer Wizard]** starts.

 **Note**

- With Windows XP, Click **[Add a printer]**.

**4** Click **[Next]**.

**5** After making sure that the **[Local Printer]** option has been selected, click **[Next]**.

A dialog box for selecting the printer port appears.

**6** Select the port you want to use, and then click **[Next]**.

A dialog box for selecting the manufacturer and model name appears.

**7** Click **[Have Disk]**.

A dialog box for installing the driver from a disk appears.

**8** Insert the CD-ROM into the CD-ROM drive.

**9** Change the drive name in the list box to the name of the CD-ROM drive, and then click **[Browse]**.

**10** Double-click **[DRIVERS]**, and then **[WIN2000\_XP]**. Then double-click the folder of the appropriate language for the operating system.

**11** Click **[Open]**.

**12** Click **[OK]**.

A dialog box for selecting the machine model appears.

- 13** Click to select the name of the machine whose driver you want to install, and then click **[Next]**.

A dialog box for changing the printer name appears.

 **Important**

- Select the printer driver for your machine as shown.

Machine model	Machine resolution	Priter driver
Type A 600 dpi	600 dpi	Type40 600
Type A 400 dpi	400 dpi	Type40 400 A
Type B	400 dpi	Type40 400 B

- 14** Change the name of the machine if you want, and then click **[Next]**.

- 15** If you want to share this machine over the network, select **[Share as]**. If not, select **[Do not share this printer]**. Press **[Next]** to continue.

 **Note**

- When selecting **[Share as]**, if necessary enter the location of the machine and a comment about the machine.

- 16** In the next dialog box you will be asked to print a test page. Select **[No]** and then click **[Next]**.

A confirmation dialog box appears.

 **Note**

- Print a test page after completing installation and restarting Windows.

- 17** Make sure that the settings you have set are correct, and then click **[Finish]**.

 **Note**

- If the **[Digital Signature Not Found]** dialog box appears, click **[Yes]** to continue the installation.

- 18** The installation is complete.

 **Note**

- When the machine (Type A) is equipped with certain options, make settings for them. See p.27 "Setting up options (Type A only)".



---

## Setting up options (Type A only)

---

### Limitation

- Changing the settings of the machine requires Manage Printers permission. Members of the Administrators and Power Users groups have Manage Printers permission by default. When you set up options, log on using an account that has Manage Printers permission. For details about access authority, see Help for Windows.

### Important

- If the machine is equipped with certain options, you should set up the options with the printer driver.

### Note

- When setting up options, you should access the **[Printer Properties]** dialog box from Windows. You cannot set up options by accessing the **[Printer Properties]** dialog box from an application.

### **1** Click **[Start]** on the taskbar, point to **[Settings]**, and then click **[Printers]**.

The **[Printers]** window appears.

#### Note

- With Windows XP Professional, access the **[Printers and Faxes]** window from **[Start]** on the taskbar.
- With Windows XP Home Edition, access the **[Printers and Faxes]** window by clicking **[Start]** on the taskbar. Then click **[Control Panel]**, **[Printers and Other Hardware]** and then **[Printers and Faxes]**.

### **2** Click the icon of the machine you want to use.

### **3** On the **[File]** menu, click **[Properties]**.

### **4** Click the **[Device Settings]** tab.

### **5** Use the **[Installable Options]** group to select the option, and then select the appropriate setting for the option from the drop-down list box.

### **6** After making the setting you want, click **[OK]**.

---

## Windows NT 4.0 - Installing the Raster Printer Language Printer Driver

---

### Preparation

The Windows NT CD-ROM may be required during installation. Make sure to have the CD-ROM ready before installation.

### Limitation

- Installing a printer driver requires Full Control access permission. Members of the Administrators, Server Operators, Print Operators, and Power Users groups have Full Control permission by default. When you install a printer driver, log on using an account that has Full Control permission.

### Note

- If you want to share the machine on Windows NT 4.0, use the **[Sharing]** tab in the **[Printer Properties]** dialog box to specify the alternate printer driver. For details, see the operating instructions for Windows NT 4.0.
- When prompted for the Windows 95/98/Me alternate printer driver location, select the following folder on the CD-ROM:
  - \ DRIVERS \ WIN9x\_ME \ (Language)
- When Raster Printer Language driver of Windows 95/98/Me is shared on Windows NT4.0, follow ARTICLE-ID:Q142667 of Microsoft Knowledge Base to install a printer driver.

**1** Close all applications that are currently running.

**2** Click **[Start]** on the taskbar, point to **[Settings]**, and then click **[Printers]**.

The **[Printers]** window appears.

**3** Double-click the **[Add Printer]** icon.

**[Add Printer Wizard]** starts.

**4** After making sure that the **[My Computer]** option has been selected, click **[Next]**.

A dialog box for selecting the printer port appears.

**5** Select the check box of the port you want to use, and then click **[Next]**.

A dialog box for selecting the manufacturer and model name appears.

**6** Click **[Have Disk]**.

A dialog box for installing the driver from a disk appears.

**7** Insert the CD-ROM into the CD-ROM drive.

**8** Change the drive name in the list box to the name of the CD-ROM drive, and then click **[Browse]**.

**9** Double-click **[DRIVERS]**, and then **[WINNT40]**. Then double-click the folder of the appropriate language for the operating system.

**10** Click **[Open]**.

**11** Click **[OK]**.

A dialog box for selecting the machine model appears.

**12** Click to select the name of the machine whose driver you want to install, and then click **[Next]**.

A dialog box for changing the printer name appears.

### Important

Select the printer driver for your machine as shown.

Machine model	Machine resolution	Printer driver
Type A 600 dpi	600 dpi	Type40 600
Type A 400 dpi	400 dpi	Type40 400 A
Type B	400 dpi	Type40 400 B

**13** Change the name of the machine if you want, and then click **[Next]**.

**14** If you want to share this machine over the network, select **[Shared]**. If not, select **[Not shared]**. Press **[Next]** to continue.

### Note

When selecting **[Shared]**, if necessary enter the location of the machine and a comment about the machine.

**15** In the next dialog box you will be asked to print a test page. Select **[No]** and then click **[Finish]**.

### Note

Print a test page after completing installation and restarting Windows.

**16** The installation is complete.



# 3. Basic Printing

## Printing Data from Your Computer on the Printer

For general printing, printing done with the Auto On Line function is used as an example for explanation purposes.

### Note

- Auto On Line is a function that starts printing automatically once printing starts from a computer. Pressing the **[Auto On Line]** key on the control panel lights its indicator and enables the function.

### Reference

See *Operating Instructions* for information about operation details.

---

## Printing

---

Create some data beforehand to be printed from your computer.

- 1** Make sure that the machine is turned on, and press the **[Auto On Line]** key if the Auto On Line indicator is not lit.

### Note

- When the machine is in Auto On Line status, the indicator will be lit.

- 2** Display the data to be printed on the computer, and then click **[Print]** from the **[File]** menu.

The **[Print]** dialog box appears.

- 3** Select the machine you want to use in the **[Printer]** box.

### Note

- When using Windows 95/98/Me, select the machine you want to use in the **[Name]** list box.

- 4** Click **[Preference]** to display the **[Printer Properties]** dialog box, and then click **[Advanced]** on **[Paper/Quality]** tab or **[Layout]** tab.

### Note

- When using Windows 95/98/Me/NT 4.0, enter the number of prints required, and select the print range, and then click **[OK]** to start printing.
- When using Windows 2000, click **[Advanced]** on the **[Paper/Quality]** tab or the **[Layout]** tab.

---

## Printing without proof printing

---

 **Note**

- “Auto-Print after Master Making” in Auto On Line status is available to Windows 2000/XP only.

**1** Click “Auto-Print after Master Making” in [Printer features], and then select “On” in the [Change Setting for] box.

**2** Click [Apply], and then [OK].

**3** Enter the number of prints required, and select the print range.

**4** Click [OK] to start printing.

When the machine receives data from the computer, it enters the online status and Data In indicator flashes.

 **Note**

- To stop the machine before Master Making, press **[Job Reset]** (When using Type B, press the **[Job Reset]** key). However, for a page where Master Making has begun, Master Making cannot be cancelled even if **[Job Reset]** (When using Type B, press the **[Job Reset]** key) is pressed.
- To stop the machine during printing, press the **[Clear/Stop]** key. If there is incoming data from the computer to the machine, press **[Job Reset]** (When using Type B, press the **[Job Reset]** key) to clear it.

---

## Printing after proof printing

---

 **Note**

- “Auto-Print after Master Making” in Auto On Line status is available to Windows 2000/XP only.

**1** Click “Auto-Print after Master Making” in [Printer features], and then select “Off” in the [Change Setting for] box.

**2** Click [Apply], and then [OK].

**3** Enter the number of prints required, and select the print range.

**4** Click [OK] to start printing.

When the machine receives data from the computer, it enters the online status and Data In indicator flashes. The Proof Printing page is output.

 **Note**

- To stop the machine before Master Making, press **[Job Reset]** (When using Type B, press the **[Job Reset]** key).
- If the **[Proof]** key is pressed, Proof Printing can be performed again.

**5** Check the result of the proof print.

**6** Press the **[Print]** key (When using Type B, press the **[Print Start]** key).

Printing starts.

 **Note**

- To stop the machine during printing, press the **[Clear/Stop]** key. If there is incoming data from the computer to the machine, press **[Job Reset]** (When using Type B, press the **[Job Reset]** key) to clear it.
- When there is no data to be printed afterwards, “Ready for Master Making/Printing” is displayed on the display panel.
- As this machine performs Proof Printing, one more set than the set number will be printed. For example, if the set number was two, three print sets will be printed and delivered.

3

---

### Printing a “waiting” print job

---

◆ **Type A**

When a print job acquires “waiting” status during printing, these three displays will appear alternately.

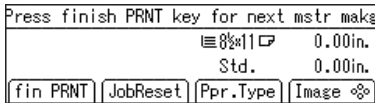
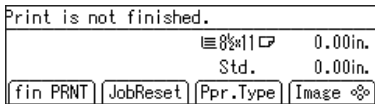
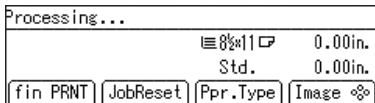

**1** Press the **[Print]** key.

 **Note**

- When the printing is finished, the machine starts master making and printing the next job. When all jobs are finished, the initial display returns.

### ❖ Type B

When a print job acquires “waiting” status during printing, these three displays will appear repeatedly.

```
Processing...(Online)
      [Print: Auto ]
[ ± 0.0in.]
```

```
Print is not finished.(Online)
      [Print: Auto ]
[ ± 0.00in.]
```

```
Press [OK] to start the next Master
      [Print: Auto ]
[ ± 0.00in.]
```

#### 1 Press the **[Print Start]** key.

##### Note

- When the printing is finished, the machine starts master making and printing the next jobs. When all jobs are printed, the initial display returns.

## Changing the Number of Prints During Printing

You can change the number of prints on the machine while it is printing.

### Important

- Change the number of prints for individual pages. For example, when the machine is printing the second page and you change the number of prints from one to two, the second page will be printed twice. The first page and pages from the third page on will only be printed once.

#### 1 Press the **[Clear/Stop]** key when printing a page for which you want to change the number of prints.

When printing is interrupted, “Processing” will be displayed.

##### Note

- When canceling printing from the following pages, press **[Job Reset]** (When using Type B, press the **[Job Reset]** key).

#### 2 Enter the number of prints using the number keys on the machine.

#### 3 Press the **[Print]** key (When using Type B, press the **[Print Start]** key).

Printing restarts. When the specified number has been printed, Master Making of the next page begins.



---

## Printing (Master Making) with the Different Size of Paper from the Original

---

When printing data with the different size of paper from the original, an error message will appear on the machine's display panel, however, you can print it forcibly.

---

### Type A

---

#### 1 Print data from your computer.

Selected paper size is unavailable, Press [MakeMstr] to continue as is, or set %s1 paper then press [OK]. [MakeMstr] [JobReset] [OK]
---

The error message appears.

#### 2 Press [MakeMstr].

The status message appears.

#### 3 Set the paper to use on Paper Feed Tray, and then press [OK].

##### Note

- When you want to cancel printing, press [JobReset].

---

### Type B

---

#### 1 Print data from your computer.

Selected paper size is unavailable. Press [Make Master] to continue as is, or set %s1 paper, then press [OK].
---

The error message appears.

#### 2 Press the [Make Master] key.

The status message appears.

#### 3 Set the paper to use on Paper Feed Tray, and then press the [OK] key.

##### Note

- When you want to cancel printing, press the [Job Reset] key.

# INDEX

## A

---

- Access Control, 15
- Access control address, 14
- Access control mask, 14
- Auto On Line key
  - Type A, 3
  - Type B, 6

## C

---

- Cancel key (Type B), 6
- Cancel (Type A), 5
- Clear Modes/Energy Saver key
  - Type A, 3
  - Type B, 6
- Clear/Stop key
  - Type A, 4
  - Type B, 7
- Connecting the Machine, 16
- Control panel
  - Type A, 3
  - Type B, 6

## D

---

- Data In indicator (Green)
  - Type A, 4
  - Type B, 7
- Default gateway address, 14
- Display, 4
- Display Panel
  - Type A, 3
  - Type B, 6
- Display panel, 4

## E

---

- Error indicator (Red)
  - Type A, 4
  - Type B, 7
- Ethernet Interface, 16
- Exit (Type A), 5

## F

---

- Frame Type (Netware), 14
- Function keys, 4

## I

---

- Interface cable, 17
- IP Address, 9

## K

---

- # key
  - Type A, 4
  - Type B, 7
- <▷ keys (Type B), 6

## M

---

- Make Master key (Type B), 7

## N

---

- Network boot, 9
- Network Settings, 9
- Next (Type A), 5
- Number key
  - Type B, 7
- Number keys
  - Type A, 4

## O

---

- Offline/Online, 5
- OK key (Type B), 6
- OK (Type A), 5
- On Line key
  - Type A, 3
  - Type B, 6

## P

---

- Parallel Cable, 17, 20
- Parallel Interface, 16
- Pnt.Size, 5
- Prev. (Type A), 5
- Print Size, 8
- Printer driver, 1
- Printing, 31
  - Windows, 31
- Print key (Type A), 4
- Print Start key (Type B), 7

## **R**

---

- Raster Printer Language, 1
  - Windows 2000, Install, 24*
  - Windows 95/98/Me, Install, 23*
  - Windows NT 4.0, Install, 28*
  - Windows XP, Install, 24*

## **S**

---

- Select (Type A), 5
- SmartDeviceMonitor for Admin, 2
- SmartDeviceMonitor for Client, 2
- Start key (Type A), 4
- Subnet mask, 14

## **U**

---

- User Tools key
  - Type A, 3*
  - Type B, 6*

## **V**

---

- Valid protocol, 14

## **W**

---

- Windows 2000
  - Raster Printer Language, Install, 24*
- Windows 95/98/Me
  - Raster Printer Language, Install, 23*
- Windows NT 4.0
  - Raster Printer Language, Install, 28*
- Windows XP
  - Raster Printer Language, Install, 24*

MEMO

MEMO

MEMO

## Note to users in the United States of America

### Notice:

This equipment has been tested and found to comply with the limits for a Class B digital device, pursuant to Part 15 of the FCC Rules. These limits are designed to provide reasonable protection against harmful interference in a residential installation. This equipment generates, uses and can radiate radio frequency energy and, if not installed and used in accordance with the instructions, may cause harmful interference to radio communications.

However, there is no guarantee that interference will not occur in a particular installation. If this equipment does cause harmful interference to radio or television reception, which can be determined by turning the equipment off and on, the user is encouraged to try to correct the interference by one more of the following measures:

**Reorient or relocate the receiving antenna.**

**Increase the separation between the equipment and receiver.**

**Connect the equipment into an outlet on a circuit different from that to which the receiver is connected.**

**Consult the dealer or an experienced radio/TV technician for help.**

### Warning

Changes or modifications not expressly approved by the party responsible for compliance could void the user's authority to operate the equipment.

### Caution (in case of 100BaseTX environment):

Network interface cable with ferrite core must be used for RF interference suppression.

## Note to users in Canada

### Note:

This Class B digital apparatus complies with Canadian ICES-003.

### Remarque concernant les utilisateurs au Canada

### Avertissement:

Cet appareil numérique de la classe B est conforme à la norme NMB-003 du Canada.

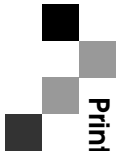

**Printer Unit Type40 RCP40 Operating Instructions Printer Reference 1**